

Espire™ Elbow Pro and Hybrid **Technical Manual**



CONTENTS

SECTION 1 - SYSTEM OVERVIEW

- 1.1 - Introduction
- 1.2 - Anatomy
- 1.3 - Pre-Installation Checklist
- 1.4 - Technical Specifications

SECTION 2 - BATTERIES AND CHARGING

- 2.1 - The Battery
- 2.2 - Battery Installation and Removal
- 2.3 - LED Indicator
- 2.4 - Battery Charger
- 2.5 - Charging the Battery

SECTION 3 - INPUTS

- 3.1 - Input Overview
- 3.2 - Input Connector Board
- 3.3 - Input Colour Coding System
- 3.4 - Haptic Feedback Motor

- 3.5 - Connecting Cables to the Input Board
- 3.6 - Strain Relief Disc

SECTION 4 - AC MYOELECTRODES WITH TRUSIGNAL™ TECHNOLOGY

- 4.1 - Electrode Overview
- 4.2 - Electrode Kits
- 4.3 - Electrode Placement
- 4.4 - Electrode Installation Instructions

SECTION 5 - PATTERN RECOGNITION

- 5.1 - Pattern Recognition Overview
- 5.2 - Coapt - COMPLETE CONTROL System Gen2
- 5.3 - Infinite Biomedical Technologies (IBT) - Sense

SECTION 6 - AXIS ELECTRONIC LOCK ACTUATOR

- 6.1 - Electronic Lock Actuator Overview
- 6.2 - Routing Cables Through the Exoskeletal Shoulder Joint
- 6.3 - Routing Cables Through the Endoskeletal Shoulder Joint

SECTION 7 - MEASURING AND CUTTING FOREARM

- 7.1 - Measuring the Forearm
- 7.2 - Protective Foam Insert
- 7.3 - Cutting the Forearm to Length

SECTION 8 - WRIST INSTALLATION

- 8.1 - Wrist Options Overview
- 8.2 - Output Wires for Terminal Devices
- 8.3 - Quick Disconnect Wrist Installation
- 8.4 - Motion Control Standard Electronic Wrist Rotator Installation
- 8.5 - Ottobock 10S17 Electronic Wrist Rotator Installation
- 8.6 - Output Wires for Pattern Recognition Systems
- 8.7 - Advanced Grip Control Installation

SECTION 9 - THE LAMINATION COLLAR AND CLAMP RING

- 9.1 - Orientation of the Lamination Collar and Clamp Ring
- 9.2 - Internal-External Rotation
- 9.3 - Attaching the Lamination Collar to the Elbow
- 9.4 - Determining Proper Orientation on Test Socket
- 9.5 - Final Adjustment with the User

SECTION 10 - FOREARM CABLE LIFT KIT (HYBRID)

- 10.1 - Cable Mounting Overview
- 10.2 - Setting Up the Cable Mounting
- 10.3 - Terminal End Connections

SECTION 11 - SETTING UP THE COUNTERBALANCE (HYBRID)

- 11.1 - Counterbalance Overview
- 11.2 - Counterbalance Adjustment

SECTION 12 - MAINTENANCE AND TROUBLESHOOTING

- 12.1 - Troubleshooting

SECTION 13 - INTENDED USE AND SAFETY

- 13.1 - Intended Use
- 13.2 - Indications and Contraindications
- 13.2 - Safety

SECTION 1 - SYSTEM OVERVIEW

The Espire Elbow system is only to be purchased, configured and fitted by a qualified prosthetist. This device is intended for use in accordance with the information contained in this document. Instruct the patient on proper use of this device before transferring device to patient.

Intended Use Statement:

The Espire Pro and Espire Hybrid Elbows are to be used exclusively for external prosthetic fittings of the upper limbs. The Espire Elbow processes the end-user's input signals to activate and control powered elbow movement.

1.1 Introduction

Thank you for purchasing the Espire Elbow system from Steeper Group. In the following document you will find information on everything from fabrication, to maintenance and care of the Espire Elbow system. Read these instructions carefully and educate the end user on all functions of this product before final delivery.

If you have any questions, concerns or comments, please contact our Customer Service team at +44 (0) 870 240 4133 (ROW), (+1) 210 481 4126 (US).

The Espire Elbow is a state-of-the-art, internally powered, myoelectric elbow prosthesis. The Espire Pro uses electrical signals from muscles to proportionally control a powered elbow and terminal devices, whereas the Espire Hybrid uses electrical signals from muscles to control terminal devices only. Steeper Group does not recommend that the device contain more than 3 degrees of freedom; the clinician should evaluate according to the combination of terminal devices that are required by the patient. The system's versatility also allows many other control schemes such as switches, linear transducers, pattern recognition systems, etc. Signals from these inputs are processed by the Espire's internal microprocessor unit and then sent to the respective devices.

1.2 Anatomy



1.3 Pre-Installation Checklist

The Espire Elbow Pro and Hybrid versions are fully assembled and undergo electronic testing verification before they are shipped.

What's in the box:

Hardware

- Espire Elbow
- Lamination Collar and Clamp Ring
- Lamination Dummy
- Strain Relief Disc
- 2 Lithium-Ion Batteries
- Battery Charger with Adapter
- iPad (included with first purchase of Pro/Hybrid model only)
- Forearm Cable Lift Kit - Hybrid only (optional extra)

Instruction Manuals

- Espire Elbow Quick Setup Guide
- Espire Elbow Technical Manual
- Espire Elbow User Manual
- Espire Elbow Fabrication Instructions
- Espire Elbow Hub App Instructions

Note: All manuals are available at steepergroup.com

Powering on the Espire Elbow



The power button is located on the medial underside of the Espire. To turn the device on or off, press and hold the power button for 4 seconds. When the device is powered on or off, a multi-coloured light on the LED indicator will flash for 1 second.

The system may also be configured with an external switch for turning the Espire Elbow on and off. Pressing the switch will also turn the system on or off.

Feature	Description
Power Button	Press and hold for 4 seconds to turn Espire ON or OFF

Elbow LED Indication - Power

Colour	Indicator	Status
Multi-Colour Blink		Power ON or OFF

Pairing Espire to the iPad

The Espire Elbow will emit a Bluetooth signal for 2 minutes after the battery is installed and the elbow is powered on, during which time it can be paired with the Hub App software. Bluetooth signal is ONLY sent when the elbow is “power cycled” (the battery is removed and re-installed). Once a Bluetooth connection is established, the LED indicator will display a blue light while paired.

Note: For information on use with the iPad, refer to the Espire Elbow Hub App Instructions - Pro and Hybrid.

Elbow LED Indication - Bluetooth

Colour	Indicator	Status
Blue Solid		Bluetooth connection

1.4 Technical Specifications

Specifications	
Weight Limit	25lb/11.3kg
Maximum Lifting Force	10 ft-lb (13.6 N-m)
Flexion Angle (preset control)	-5° - 135°
Speed (preset control)	135°/sec
Max Cable Length (AC Electrode Cable)	24”/609 mm
Mode of Operation	Continuous

Connections	
Inputs	12
Outputs	4

Device Operation - Internally Powered	
Battery (Removable)	Smart Li-Ion 10.8 V, 3,000 mAh, 32 Wh
Time to Full Charge	3.5 hours
Voltage (Elbow)	11.1 V nominal
Voltage (Hand)	7.4 V regulated
Charger	100-250 VAC, 24 V, 2.5A DC

Wireless	
Connection	Bluetooth 4.2
Maximum Speed	24 Mbps
Maximum Range	330ft/10m
Operating Frequency	2.402 - 2.480 GHz
BLE Power	4dBm

System Requirements	
Hardware Minimum Requirements	iPad 5th generation or later with iOS 10.3 or later
Software	Download the Espire Hub App from the Apple App Store

Environmental Use Conditions	
Charging (Temperature)	32°F to 113°F (0°C to +45°C)
Operating (Temperature)	41°F to 104°F (5°C to 40°C)
Storage & Transport (Temperature)	-4°F to 140°F (-20°C to +60°C) *
Operating Relative Humidity	15% to 90%

*Note: If storing device above or below operating temperature, allow the device to return to within operating temperature range and leave the device to sit for 15 minutes before using.

IP Rating

IP22 Protected from touch by fingers and objects greater than 12 millimetres. Protected from water spray less than 15 degrees from vertical.

List of Currently Approved Terminal Devices

(Please contact Steeper Group for devices not listed)

Manufacturer	Product
Steeper Group	All Steeper Myoelectric Hands
Ossur	iLimb hands
Ottobock	Bebionic hand, Electric Greifer, Electronic Wrist Rotator, SensorHand Speed, Other Ottobock Myoelectric Hands
Taska Prosthetics	Taska Hand
Motion Control	Electronic Wrist Rotator, ETD2
Hy5	Hy5 hand

SECTION 2 - BATTERIES AND CHARGING

2.1 The Battery

The Espire Elbow system is supplied with two removable lithium-ion batteries. This battery supplies 3000 mAh at 11.1 volts for the elbow and 7.4 volts for the terminal device(s). It is advised to rotate use of these batteries, keeping one as a spare for backup power. For most users, one battery will last an entire day*, depending on the prosthetic components, condition of the battery and the frequency of use.

The batteries are shipped with a partial-charge (up to 30%). We recommend charging both batteries to 100% upon receipt of the Espire Elbow system.

**based on average use during an 8-hour period*



Caution: Use only the Steeper Group manufactured Espire Elbow battery pack and the provided battery charger with the Espire Pro and Hybrid systems. Always follow the manufacturer's instructions for proper removal of and replacement of battery pack.



Note: To extend battery life, rotate battery usage on a weekly or monthly basis.



Note: If storing the Espire Elbow for an extended period without using, remove battery pack from the elbow before storage.

Battery Fuel Gauge



A fuel gauge is located on the side of the battery for quickly checking the charge status.

Indicator	Symbol	Battery Status
5 Bars	■■■■■	Full Charge
No Bars	None	No Charge

2.2 Battery Installation and Removal

Batteries can be removed and replaced as necessary. To remove the battery, simply push the battery cover clip and gently lift it off the elbow. Use the pull tab to remove the battery.

Installing a battery is the reverse process. Insert the battery into the elbow, ensuring that the pull tab is accessible for future removal. Then, apply the battery cover. The battery cover clip will “click” into place when seated.

Elbow - Bottom View

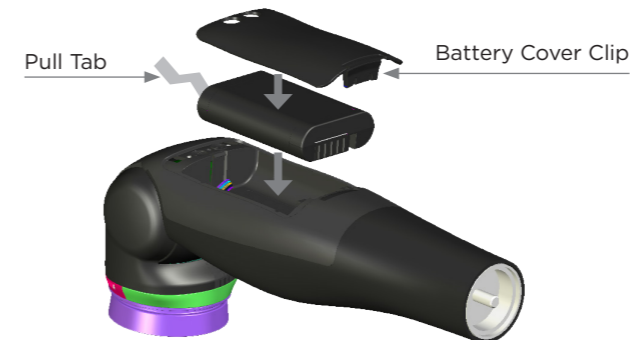

2.3 LED Indicator

The Espire Elbow is equipped with a state-of-charge LED indicator. This indicator tells the user how much life is left in their current battery. The Espire must be powered on to use this feature.

Press the power button for one second to activate the LED indicator light on the forearm. The number of blinks indicates the state of the charge.

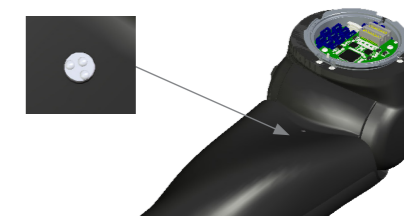

Feature	Description
 Power Button	Press and hold for 1 second to indicate the battery status

Elbow LED Indications - Battery

Colour	Indicator	Battery Status
4 Green Blinks	■ ■ ■ ■	100% Charged
3 Green Blinks	■ ■ ■	Less Than 75%
2 Green Blinks	■ ■	Less Than 50%
1 Green Blink	■	Less Than 25%
Yellow Solid	■	Critically Low - Charge Battery

2.4 Battery Charger

Espire Elbow Pro and Hybrid systems are supplied with a Smart Charger for the lithium-ion battery. The charger is recommended for daily use and will assure that the battery will receive a full charge and provide maximum running time. There are two charger types (single-bay or dual-bay) and three power adapter options (US, UK, or European) to match the needs of different regions. There is also a car charger available.



Caution: Using a different AC adapter than the one provided with the battery charger may cause damage to the Espire battery or battery charger.

Single-Bay Charger

(Also available in Dual-Bay)



2.5 Charging the Battery

Charging the Espire Elbow Battery

1. Place the charger on a flat, level surface away from sources of heat and moisture. Plug the AC connector from the power supply into the back of the charger and connect the power supply to the main AC supply using the cable supplied.
2. If the battery you wish to charge is inside of the Espire Elbow, it must first be removed from the battery compartment. Remove the battery cover via the clip and remove the battery by using the pull tab.
3. Place the battery into the battery bay ensuring that the 5-way connector is fully seated. The LEDs in the status window will provide status information and the charger will automatically begin charging.

Recharge time from empty is approximately 3.5 hours.

Battery Charger LED Indications

Colour	Indicator	Battery Status
Green Blinking		Charging
Green Solid		Fully Charged
Red Solid		Error (Contact Steeper Group)

SECTION 3 - INPUTS

3.1 Input Overview

The Espire Elbow is compatible with many types of inputs, which will be installed with the configuration specified at the time of ordering.

List of Supported Inputs

Manufactured by Steeper Group:

- AC Myoelectrodes with TruSignal™ Technology (see section 4)
- Linear Transducers
- Touch Pads
- DC Cased Electrodes (requires Espire input cable)

Other Manufacturers:



Note: Input components from other manufacturers will require a unique wire harness and must be installed and tested by Steeper Group prior to delivery.

- Switches - Single-State, Dual-State, Bump, etc. (requires Espire input cable)
- Remote Power Switches

Items Not Listed: Contact Steeper Group for customised cable and adapter options.

Other Control Methods:

TMR

- Can utilise either AC or DC electrodes

Pattern Recognition (see Section 5)

- COMPLETE CONTROL System Gen2 - Coapt
- Sense - Infinite Biomedical Technologies (IBT)

3.2 Input Connector Board

Every Espire Elbow will be shipped with the configuration specified at the time of ordering. Your current setup can be viewed in the Espire Hub App under the diagnostics tab: Espire Hub App > System Settings > Diagnostics > Connections.

The table adjacent lists the location, the type of connection that can be used, and its setup type.



Note: The image below is shown with the TruSignal circuit board installed, which includes connections A-D for use with TruSignal AC electrodes.

This board is only factory installed when specified during the order process but can be added later if desired. Contact Steeper Group for more information.

Input Connector Board

WITH TRUSIGNAL BOARD

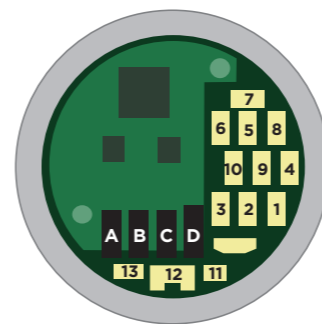

Posterior

NO TRUSIGNAL BOARD

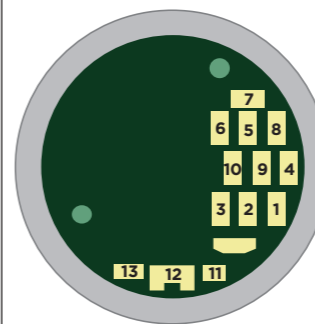

Posterior

Board Location	Input Option	Setup Type
A + D	TruSignal AC Electrodes	1-site or 2-sites
A + B + D	TruSignal AC Electrodes w/TMR	4-sites
A + B + C + D	TruSignal AC Electrodes w/TMR	6-sites
1 - 9	DC Electrodes DC Electrodes w/TMR Linear Transducer Touch Pads Switches	Any combination up to 9 inputs
10	Remote Power Switch	1 input
11	Shoulder Lock/Unlock	1 input
12	Auxiliary Port	---
13	Haptic Feedback	1 output

3.3 Input Colour Coding System

Coloured labels will be applied to the wires during the order fulfillment process to identify the input type and its location on the input board.

Board Location	Input Type	Colour
A	AC Pair 1	● Red
	AC Pair 2	● Orange
B	AC Pair 3	● Yellow
	AC Pair 4	● Green
C	AC Pair 5	● Blue
	AC Pair 6	● Purple
D	AC Grounds	○ White
1 - 9	Linear Transducer	● Purple
	Touchpads	■ Yellow/Green Stripe
	DC Electrodes	● Blue
10	Remote Power Switch	● Black
11	Shoulder Lock (Output)	● Grey
13	Haptic Feedback (Output)	● Black

3.4 Haptic Feedback Motor



A haptic feedback motor is located on the underside of the strain relief disc. It vibrates to alert the end user when a pre-programmed action occurs, such as confirmation of a successful myoelectric switching event. This function can be configured in the Espire Hub App.

To connect the haptic feedback motor, plug the cable to the input board (port 13) like any other connector.

3.5 Connecting Cables to the Input Board

1. Apply silicone grease to the plug connectors before inserting into the board.
2. When attaching cables, note the proper orientation. The connectors are “keyed” or asymmetrical to assure proper alignment. The connector should plug in easily and is held in place with friction.
3. Once the cables are attached, apply more silicone grease on top of the connectors to prevent moisture from entering receptacles.
4. When removing cables, pull close to the connector to avoid pulling on the wires. Wires that become loose could cause intermittent operation.

3.6 Strain Relief Disc

The strain relief disc prevents accidental disconnection of the input wires and acts as a seal to prevent moisture and dirt from entering the area with the receptacles.

1. Thread the input wires through the centre hole of the disc (figure 1), then connect the wires to the board. Apply silicone grease to the plug connectors before inserting into the board (see section 3.5).
2. Fasten the wires to the strain relief disc using the provided zip-tie. Cut excess zip tie material, ensuring no sharp edges remain. This is necessary to prevent accidental wire disconnection.

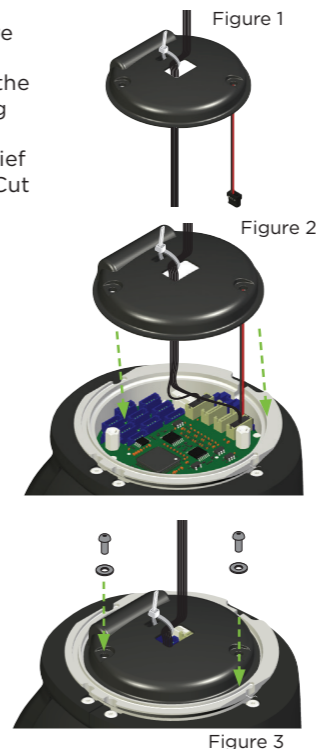

Sealing the Input Board

1. Apply a small amount of silicone grease at the perimeter seal between the disc and the ring.
2. Line up the fastener holes on the disc to the mounting threads on the input board, then gently press the disc to the board. (Figure 2)
3. Use (two) M2 x 5mm fasteners and washers to secure the disc to the input board (figure 3). A 1.3mm Allen wrench has been provided to tighten the fasteners finger-snug (2 in-lb/0.23 N-m).
4. It is important to seal the holes where the wires pass through the strain relief disc before final assembly of the socket.

Apply RTV silicone over the strain relief hole, zip-tie hole, and wires (figure 4).

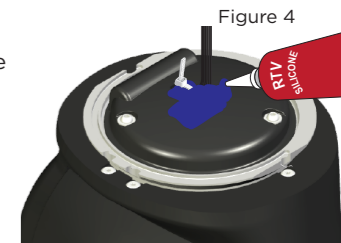

Coapt Strain Relief Disc

Note: Due to a taller input connector, the Coapt Gen2 system requires a specifically-shaped strain relief disc. The Coapt EMG Interface Cable Connector increases the elbow build height by 0.15”/3.8mm.

1. Thread the COMPLETE CALIBRATION Button wire ribbon through the slotted hole of the disc, then attach the connector to the board.
2. Insert the EMG Interface Cable connector through the matching shape on the disc, then attach to the board.
3. Fasten the wires to the strain relief disc using the two provided zip-ties. This is necessary to prevent accidental wire disconnection, twisting, and damage.
4. Use (two) M2 x 5mm fasteners and washers to secure the disc to the input board. A 1.3 mm Allen wrench has been provided to tighten the fasteners finger-snug (2 in-lb/0.23 N-m). It is not necessary to seal the input board.

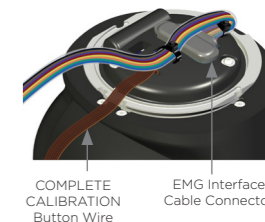

SECTION 4 - AC MYOELECTRODES WITH TRUSIGNAL™ TECHNOLOGY

4.1 Electrode Overview

Steeper's AC electrodes are an effective and convenient way to increase signal resolution. These are designed to work exclusively with the Espire Elbow; however, cased DC electrodes are also compatible.



Type BF Applied Part

TruSignal Technology

The electrodes utilise TruSignal™ technology; a unique process for buffering a signal immediately, sending it to the microprocessor, and then amplifying it.

The benefit of amplifying the signal later in the process is that it results in a cleaner and clearer signal than other electrode options. The result is better slow speed control of the elbow and its accessories.

How it Works:

1. TruSignal board, located directly at the electrode, "cleans" signal and lowers impedance.
2. Cleaned AC signal delivered to Espire microprocessor.
3. Software in the elbow amplifies the signal corresponding to the patient's calibration.



4.2 Electrode Kits

An electrode kit consists of a wire harness with TruSignal boards attached, and a set of metal electrodes. To order an electrode kit by part number, identify the number of myo sites (1 site, 2 site, 4 site, 6 site), wire length (6 in, 12 in, 24 in), and dome size (paediatric, medium, large).

TruSignal AC Electrode Kit Part Numbers

PART ID	MYO SITES	WIRE LENGTH	DOME SIZE
CP-TLE	1 / 2 / 4 / 6	06 / 12 / 24	P / M / L

Example Part Number:

CP-TLE-212-M - TruSignal AC Electrode Kit, 2 Site, 12 in, Medium Dome

Remote Metal Electrodes



The remote metal electrodes are Cavity-Backed™ for use with the electrode kits and snap onto the TruSignal boards. They have a recess on the back allowing the inner socket material to deform into this space, thus reducing the bulge on the outer socket.

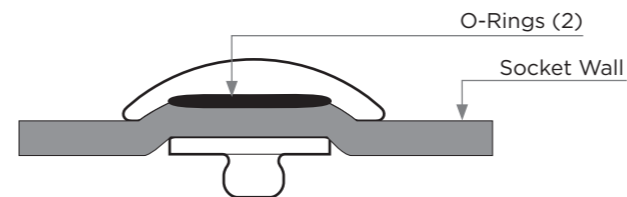

Dome selection is based on the patient's needs. Medium electrodes are most commonly used, however, if the patient has significant soft tissue over the myoelectric sites, the large electrodes are recommended. Paediatric electrodes are for paediatric applications.

Large

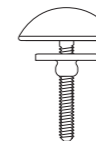

Medium

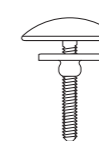

Paediatric

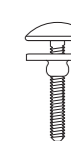

4.3 Electrode Placement

Since the electrodes are independent, the clinician can place these where they want in the socket. Each site has two active electrodes. In general, each pair of electrodes should lie along the longitudinal axis of the muscle with an edge-to-edge spacing of not more than 1cm. An additional pair of reference electrodes (grounds) should be located off-axis, away from the active electrodes where they will not interfere with muscle signals.



Example: 6-Site Myo Placement (TMR) Shoulder Disarticulation

Electrode Type	Location
● AC Pair 1	Pectoralis Major
● AC Pair 2	
● AC Pair 3	
● AC Pair 4	
● AC Pair 5	
● AC Pair 6	
○ AC Grounds	Away from muscle signal

Metal Electrode Spacing

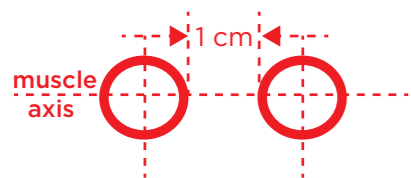

Example: 2-Site Myo Placement Transhumeral

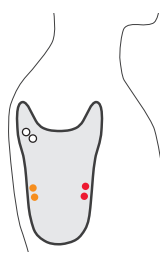

Electrode Type	Location
● AC Pair 1	Bicep
● AC Pair 2	Tricep
○ AC Grounds	Away from muscle signal

4.4 Electrode Installation Instructions



1. Use an awl or other small tool with a sharp point to puncture the centre of the electrode location. For test sockets and rigid inner sockets, a power drill with $\frac{3}{32}$ " drill bit is recommended.



2. Insert the post of the electrode dome through the inside of the socket. The dome should be inside of the socket where it will contact the residual limb.



3. Place the nut snap onto the post of the electrode dome and hand tighten. Use the provided hex driver (CP-HXD) to tighten snugly.



4. Use a pair of wire snips to trim the post. The post should not protrude beyond the snap when secured in place.



5. Snap the electrode boards onto the electrode dome posts and ensure they are attached securely. The location of the electrodes can always be changed later if desired.



Info: For more information on electrode fabrication, see Espire Elbow Fabrication Instructions.

SECTION 5 - PATTERN RECOGNITION

5.1 Pattern Recognition Overview

Pattern recognition is a distinctive control method that utilises an array of myoelectrodes along with programmed algorithms, to identify muscle patterns in a user's movements. This allows the system to "learn" and move the device more intuitively than with direct control methods.

The Espire Elbow is compatible with two pattern recognition systems. The kit type must be specified at the time of ordering. Refer to manufacturer for specific part numbers.

5.2 Coapt - COMPLETE CONTROL System Gen2

Kit Types for COMPLETE CONTROL System Gen2:

- Espire Pro - with standard grip
- Espire Pro - with advanced grip
- Espire Hybrid - with standard grip
- Espire Hybrid - with advanced grip

The COMPLETE CONTROL Gen2 must be ordered directly from Coapt but will ship from Steeper Group. The Coapt circuit board will be pre-installed to the Espire Elbow input connector board and the systems will be tested together before delivery to the customer. The circuit board is designed to fit the Gen2 EMG Interface Cable, COMPLETE CALIBRATE Button, and advanced grip control cable (if specified).

Coapt Circuit Board for Espire Pro and Hybrid

The Espire Elbow will be shipped with the configuration specified at the time of ordering. Your current setup can be viewed in the Espire Hub App under the diagnostics tab: Espire Hub App > System Settings > Diagnostics > Connections.

The table below lists the location, the connection that can be used, and its setup type.

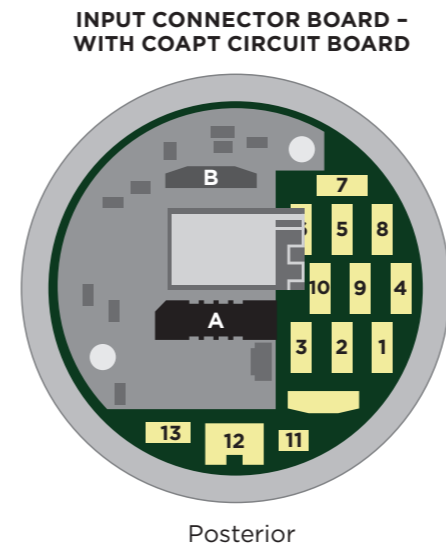

Board Location	Input Option	Setup Type
A	EMG Interface cable	8-sites
B	COMPLETE CALIBRATE Button	1 input
1 - 9	Touch Pads Switches	Any combination up to 9 inputs
10	Remote Power Switch	1 input
11	Shoulder Lock/Unlock	1 output
12	Advanced Grip Control	1 output
13	Haptic Feedback	1 output

5.3 Infinite Biomedical Technologies (IBT) - Sense

Kit Types for Sense System:

- Espire Pro and Hybrid – with standard grip
- Espire Pro and Hybrid – with advanced grip

The Sense system must be ordered and shipped directly from IBT. The IBT circuit board will be pre-installed to the Espire Elbow input connector board and the systems will be tested together before delivery to the customer. The circuit board is designed to fit the Sense Controller Cable and advanced grip control cable (if specified).

IBT Circuit Board for Espire Pro and Hybrid

Espire Elbow will be shipped with the configuration specified at the time of ordering. The current setup can be viewed in the Espire Hub App under the diagnostics tab: Espire Hub App > System Settings > Diagnostics > Connections.

The table below lists the location, the connection that can be used, and its setup type.

INPUT CONNECTOR BOARD - WITH IBT CIRCUIT BOARD

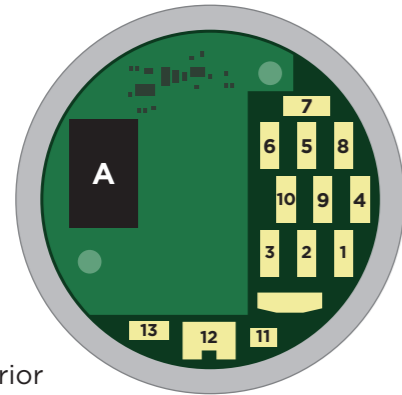

Board Location	Input Option	Setup Type
A	Sense Controller	8-sites
1 - 9	Touch Pads Switches	Any combination up to 9 inputs
10	Remote Power Switch	1 input
11	Shoulder Lock/Unlock	1 output
12	Advanced Grip Control	1 output
13	Haptic Feedback	1 output

SECTION 6 - AXIS ELECTRONIC LOCK ACTUATOR

6.1 Electronic Lock Actuator Overview

The Axis Shoulder Joint is available with an electronic lock actuator in both exoskeletal and endoskeletal versions. The shoulder is powered by the Espire Elbow battery and controlled via the input of choice. It requires an output cable to actuate the lock, which connects to the input board.

6.2 Routing Cables Through the Exoskeletal Shoulder Joint

In the exoskeletal version, both input and output wires are routed through a channel between the yoke plate and the humeral plate.

1. A hole entering the socket must be provided for the Axis output wire.
2. Input wires travel from the input control (electrodes, switches, etc) to the input connector board. The Axis output wire travels from the shoulder joint to the input connector board.
3. Attach cables to input board.

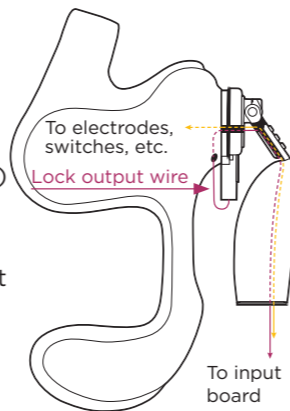

Axis Shoulder Joint - Side View

i Info: For more information on electrode fabrication, see Espire Elbow Fabrication Instructions.

6.3 Routing Cables Through the Endoskeletal Shoulder Joint

In the endoskeletal version, both input and output wires are routed through the centre of the shoulder joint.

1. A hole entering the socket must be provided for the Axis output wire.
2. Run all cables from socket, through centre of shoulder joint, down outside of pylon, to elbow input board.
3. Fasten cables to pylon with tape.
4. Insert cables through one of two openings on the endo adapter.
5. Attach cables to input board.

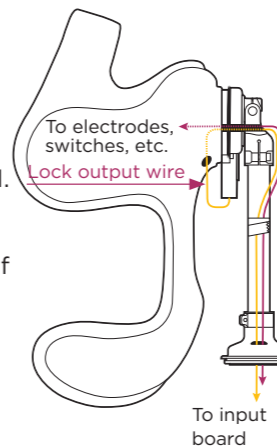

Axis Shoulder Joint - Side View

i Info: For more information on endo adapter assembly, see Espire Elbow Endo Adapter Kit Instruction Sheet

i Info: Use of a cosmetic cover is recommended to encase and protect cable wires.

SECTION 7 - MEASURING AND CUTTING FOREARM

7.1 Measuring the Forearm

The Espire Elbow is available in two forearm lengths, Small (45mm Ø wrist) and Standard (50mm Ø wrist). Forearm measurement can be referenced from the centre of the elbow. A removable sticker is applied to the forearm to reference the maximum cut area.

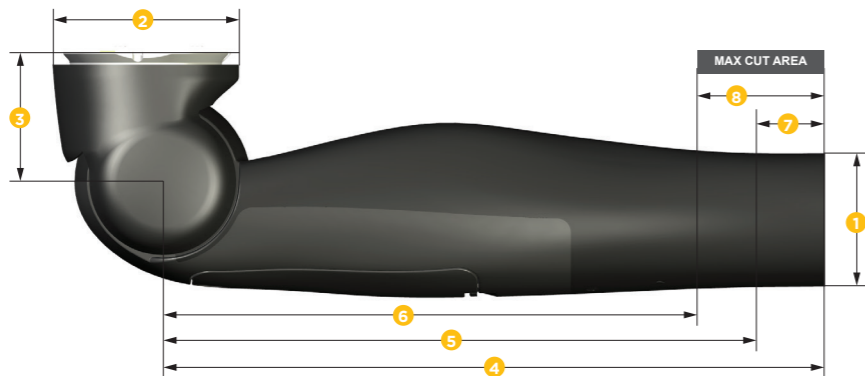

	Dimension	Measured From	Small	Standard
1	Diameter - Wrist	---	45mm	50mm
2	Diameter - Upper Arm Connection	---	70mm/2.74in	70mm/2.74in
3	Minimum Build Height	Residual Limb to Elbow Centre	48mm/1.89in	48mm/1.89in
4	Overall Length	Elbow Centre	248mm/9.75in	273mm/10.73in
5	Minimum Length - w/rotator	Elbow Centre	222mm/8.75in	225mm/8.86in
6	Minimum Length - w/out rotator	Elbow Centre	200mm/7.88in	225mm/8.86in
7	Maximum Cut Area - w/rotator	Distal End	25mm/1.00in	48mm/1.875in
8	Maximum Cut Area - w/out rotator	Distal End	48mm/1.875in	48mm/1.875in

7.2 Protective Foam Insert

A foam insert is installed prior to shipping to protect the output wires and to prevent dust or debris from entering the circuit board.



Note: Foam insert must be in place prior to cutting the forearm and completing wrist fabrication. Failure to use the insert will damage the Espire Elbow.

7.3 Cutting the Forearm to Length

1. Measure the desired length of the forearm.
2. Cut the forearm, preferably with a band saw.
3. Continue with wrist fabrication (section 8).



Note: It is important to avoid subjecting the system to excessive vibration such as that caused by a carbide-tip saw blade or a sanding belt/disk.

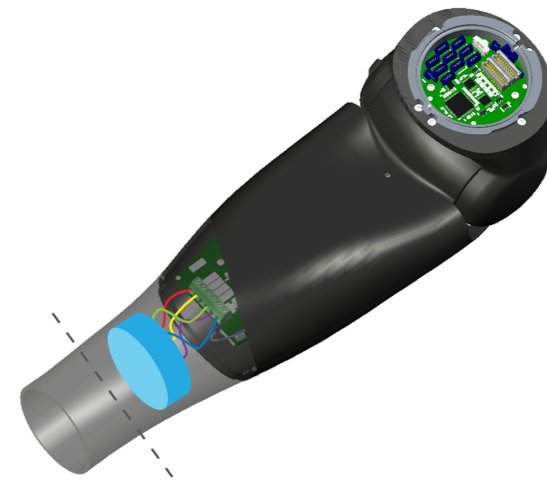

SECTION 8 - WRIST INSTALLATION

8.1 Wrist Options Overview

The Espire Elbow is compatible with three wrist options. The wrist type must be specified at the time of ordering.

Non-Powered Wrists			
Type	Manufacturer	Small Elbow	Standard Elbow
Quick Disconnect Wrist	Steeper Group *QD Wrists from other manufacturers also compatible	45mm wrist	50mm wrist

Powered Wrists			
Type	Manufacturer	Small Elbow	Standard Elbow
Standard Electronic Wrist Rotator	Motion Control	n/a	50mm wrist
10S17 Electronic Wrist Rotator	Ottobock	45mm wrist	50mm wrist

8.2 Output Wires for Terminal Devices

Output wires will already be installed into the circuit board of the Espire Elbow. They can easily be retrieved from inside of the forearm and connected to the desired device. The wires will be colour coded and simply need to be plugged into the appropriate terminal device. Wires that are not needed can be tucked away into the forearm.

See section 8.6 for output wires with pattern recognition systems.

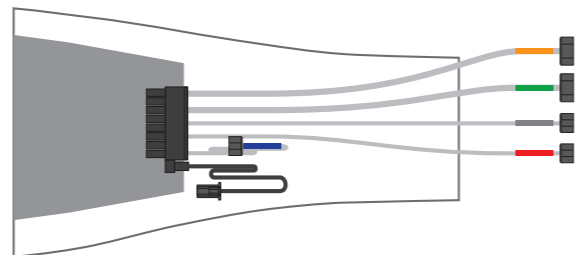

Colour	Output Type
● (Orange)	Hand-Open
● (Green)	Hand-Close
● (Grey)	Wrist
● (Red)	Power
● (Blue)	Bus Communication (Not Used)
● (Black)	(Not Used)

8.3 Quick Disconnect Wrist Installation

Lamination Ring

If no wrist rotator is desired, a quick disconnect wrist can be installed using the lamination ring. Bond the lamination ring into the forearm of the Espire Elbow before installing the quick disconnect wrist.



Refer to the manufacturer's instructions for more detailed fabrication and assembly information.

Wiring

Connector Orientation - The curve of the socket connectors should face inward toward the centre of the wrist.

1. Insert the orange (hand-open) cable into the left pins labeled "2".
2. Insert the green (hand-close) cable into the right pins labeled "2".
3. Insert the red (power) cable into the pins labeled "1".

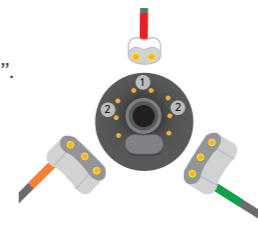

Caution: Do not insert the 2-socket connector (power) into the wrong pin receptacles. This may damage the hand or Espire system.



Note: If the 3-socket connectors (hand-open/hand-close) are attached to the wrong pin receptacles labeled "2", the open-close functions will operate in reverse.

8.4 Motion Control Standard Electronic Wrist Rotator Installation



Note: The Motion Control Standard Electronic Wrist Rotator will only fit the standard size Espire Elbow with 50mm wrist opening.



Lamination Collar



Lamination Collar with Wrist Rotator Inserted

Lamination Collar Prefabrication Fit Check

1. Insert the electronic wrist rotator into the lamination collar and secure with 1 mounting screw. Verify the rotator does not contact the distal end of the Espire control board.
2. Remove and separate the rotator from the lamination collar.
3. Bond the lamination collar into the forearm of the Espire Elbow before installing the electronic wrist rotator.

Refer to the manufacturer's instructions for more detailed fabrication and assembly information.

Wiring

Connector Orientation - The curve of the socket connectors should face inward toward the centre of the wrist; however, the 2-socket wrist connector is reversible.

1. Insert the orange (hand-open) cable into the left pins labeled "CH-A".
2. Insert the green (hand-close) cable into the right pins labeled "CH-B".
3. Insert the grey (wrist) cable into the pins labeled "wrist".
4. Insert the red (power) cable into the pins labeled "hand".

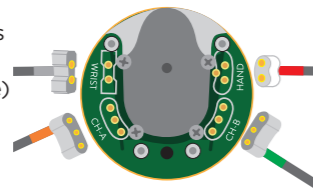

Caution: Do not insert the 2-socket connectors (wrist or power) into the wrong pin receptacles. This may damage the hand or Espire system.



Note: If the 3-socket connectors (Hand-Open/Hand-Close) are attached to the wrong receptacles labeled "CH-A" and "CH-B", the open-close functions will operate in reverse.

8.5 Ottobock 10S17 Electronic Wrist Rotator Installation

Lamination Ring

Bond the lamination ring into the forearm of the Espire Elbow before installing the electronic wrist rotator.

Refer to the manufacturer's instructions for more detailed fabrication and assembly information.



Wiring

Connector Orientation - The curve of the socket connectors should face inward toward the centre of the wrist; however, the 2-socket wrist connector is reversible.

1. Insert the orange (hand-open) cable into the left pins labeled "2".
2. Insert the green (hand-close) cable into the right pins labeled "2".
3. Insert the factory provided motor connection into the left pins labeled "3".
4. Insert the grey (wrist) cable into the right pins labeled "3".
5. Insert the red (power) cable into the left pins labeled "1".

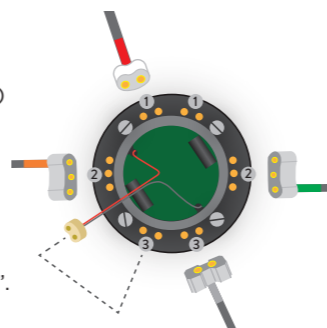

Caution: Do not insert the 2-socket connectors (wrist, power, or motor) into the wrong pin receptacles. This may damage the hand or Espire system.



Note: If the 3-socket connectors (hand-open/hand-close) are attached to the wrong pin receptacles labeled "2", the open-close functions will operate in reverse.

8.6 Output Wires for Pattern Recognition Systems

When the Espire is configured with pattern recognition (Coapt or IBT), additional output passthrough wires will be installed to accommodate advanced grip control. If advanced grip control is not being used, wires that are not needed will be tucked away into the forearm.

The wires provided vary by grip option and hand choice:

Wiring Option 1 - No Advanced Grip - All Hands

Colour	Output Type
● (Orange)	Hand-Open
● (Green)	Hand-Close
● (Grey)	Wrist
● (Red)	Power
● (Blue)	Bus Communication (Not Used)
● (Black)	(Not Used)

Wiring Option 2 - Hands with Advanced Grip and 4-Band Coaxial Plugs

Colour	Output Type
● (Orange)	(Not Used)
● (Green)	(Not Used)
● (Grey)	Wrist
● (Red)	Power
● (Blue)	Bus Communication (Not Used)
● (Orange) ● (Green)	Passthrough & Hand-Open Hand-Close

Wiring Option 3 - Hands with Advanced Grip and 6-Band Coaxial Plugs

Colour	Output Type
● (Orange)	Hand-Open
● (Green)	Hand-Close
● (Grey)	Wrist
● (Red)	Power
● (Blue)	Bus Communication (Not Used)
● (Purple)	Passthrough

8.7 Advanced Grip Control Installation

The Espire Elbow accommodates advanced grip control, which is used with pattern recognition systems and multiarticulating hands that have pattern recognition capabilities.

Wrist wiring options are based on whether the hand supports advanced grip capabilities, and if it's compatible with either a 4- or 6- band coaxial plug. Customers should contact Steeper Group or a Coapt representative for which option (Wiring Option 2 or Wiring Option 3) will be correct for the type of hand they are planning.



Note: Not all multiarticulating hands have advanced grip control capabilities; verify with the manufacturer.

Wiring Option 1 - No Advanced Grip - All Hands

If no advanced grip is being used, refer to the regular wrist installation instructions (see sections 8.3, 8.4, and 8.5).

Wiring Option 2 - Hands with Advanced Grip and 4-Band Coaxial Plugs

Hands with Advanced Grip using a 4-Band Coaxial Plug can be used with regular wrist models; however, Wiring Option 2 is required. Refer to the regular wrist installation instructions (see sections 8.3, 8.4, and 8.5).

Wiring Option 3 - Hands with Advanced Grip and 6-Band Coaxial Plugs

Hands with Advanced Grip using a 6-Band Coaxial Plug require a wrist model with an additional socket connector (passthrough cable). There are currently two wrist manufacturers who offer this option.

Non-Powered Wrists			
Type	Manufacturer	Small Elbow	Standard Elbow
Quick Disconnect Wrist	Steeper *QD Wrists from other manufacturers also compatible	45mm wrist	50mm wrist

Connector Orientation - The curve of the socket connectors should face inward towards the centre of the wrist.

1. Insert the orange (hand-open) cable into the left pins labeled "2".
2. Insert the green (hand-close) cable into the right pins labeled "2".
3. Insert the red (power) cable into the pins labeled "1".
4. Remove the cover from receptacle "A", then insert the purple (pass through) cable into the pins labeled "A".

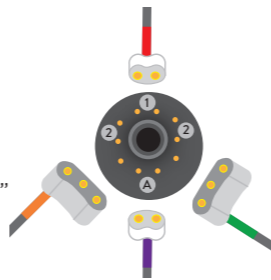

Caution: Do not insert the 2-socket connectors (power or pass through) into the wrong pin receptacles. This may damage the hand or Espire system.



Note: If the 3-socket connectors (hand-open/hand-close) are attached to the wrong pin receptacles labeled "2", the open-close functions will operate in reverse.

Powered Wrists			
Type	Manufacturer	Small Elbow	Standard Elbow
Standard Electronic Wrist Rotator with 6-Band Coaxial Plug	Motion Control	n/a	50mm wrist

Wiring

Connector Orientation - The curve of the socket connectors should face inward toward the centre of the wrist; however, the 2-socket wrist connector is reversible.

1. Insert the orange (hand-open) cable into the left pins labeled "CH-A".
2. Insert the green (hand-close) cable into the right pins labeled "CH-B".
3. Insert the grey (wrist) cable into the pins labeled "wrist".
4. Insert the red (power) cable into the pins labeled "hand".
5. Insert the purple (passthrough) cable into the bottom 2-pin receptacle.

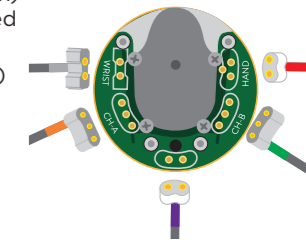

Caution: Do not insert the 2-socket connectors (wrist, power, or passthrough) into the wrong pin receptacles. This may damage the hand or Espire system.



Note: If the 3-socket connectors (hand-open/hand-close) are attached to the wrong pin receptacles labeled "CH-A" and "CH-B", the open-close functions will operate in reverse.

SECTION 9 - THE LAMINATION COLLAR AND CLAMP RING

9.1 Orientation of the Lamination Collar and Clamp Ring

The lamination collar must be oriented properly relative to the patient socket to allow for correct internal / external humeral rotation and to protect the wiring of the Espire Elbow. *(Colours for representation only.)*

Anti-rotation stop pin located internally on the underside of the lamination collar

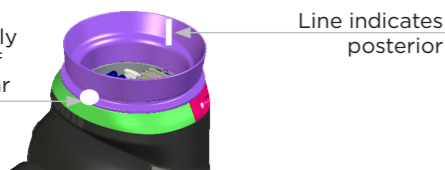

The clamp ring (left below) is a two-piece assembly that is uniquely shaped to fit the profile of the Espire Elbow. When assembled to the elbow, the clamp screws will face posterior.



9.2 Internal-External Rotation

The Espire is designed with humeral anti-rotation stop pins to prevent 360-degree rotation. This feature is to prevent input wires from being twisted and potentially damaged. The stop pins provide 100° external / 100° internal rotation for a total range of 200°.

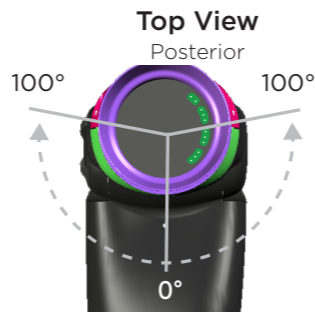

i Info: Normal human range of motion is 30° externally and 135° internally.

9.3 Attaching the Lamination Collar to the Elbow

1. Disassemble the clamp ring by removing the fasteners.
2. Place the lamination collar (or socket with attached collar) near top of the elbow.
3. Plug appropriate cables into the input board (if applicable, see section 3.2).

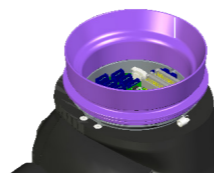

4. With the lamination collar in place, insert Clamp Ring A around both the anterior end of the lamination collar and elbow attachment.
5. Then insert Clamp Ring B around both the posterior end of the lamination collar and elbow attachment.
6. Insert the fasteners and torque, (hand tighten to start and then tighten until appropriate friction is achieved for humeral rotation). Apply equal torque to both fasteners.

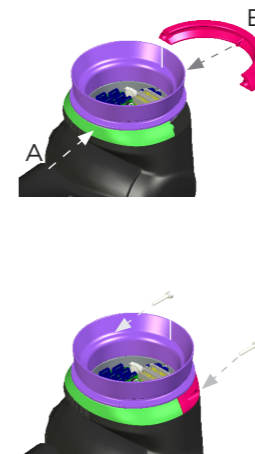

9.4 Determining Proper Orientation on Test Socket

The lamination collar attachment to the socket must provide a clinically acceptable measurement from centre axis of shoulder to centre axis of elbow. The appropriate elbow carry angle must also be established, preferably for full extension.

1. Test the collar orientation by placing it under the user's test socket with the orientation line facing posterior. It may be necessary to extend the collar away from the socket to establish the correct elbow position. Mark where the collar contacts the socket or extension material.
2. Remove the clamp ring from the lamination collar and elbow.
3. Temporarily attach the collar to test socket using fibre

4. Re-attach the elbow to the lamination collar and test socket. Rotate the forearm clockwise and anti-clockwise and verify the stop positions at 100° from centre (see section 6.2). Rotate the collar accordingly to adjust the amount of internal or external rotation.
5. Temporarily fit the arm to the user, verify that the position, carry angle, and elbow centre are appropriate. Record the data.
6. Create a new mould for the definitive socket. Transfer the measurements and position from the test socket.
7. Fabricate the definitive socket with chosen inputs and applicable prosthetic materials.

i Info: For more information on lamination, see Espire Elbow Fabrication Instructions.

9.5 Final Adjustment with the User

The humeral rotation is adjusted with a 2.5mm hex key that is supplied with the clamp ring. While the user is wearing the prosthesis, adjust the friction until it is most comfortable. This friction can be adjusted as needed.

f Note: Over-tightening this screw may damage the screw threads. Use small, controlled adjustments until the desired amount of friction is reached.

SECTION 10 - FOREARM CABLE LIFT KIT (HYBRID)

10.1 Cable Mounting Overview

Elbow Size	Mounting Location	Standard
Small (45mm wrist)	Medial	Standard
	Lateral	Standard
Standard (50mm wrist)	Medial	Extended
	Lateral	Standard

The forearm cable lift kit can be mounted to the forearm to provide elbow flexion and/or prehensile control.

A cable mounting bracket is located internally (both medially and laterally) on all Espire Elbow models, except Espire Pro. Three indentations on the surface of the forearm indicate where a hole may be drilled to attach the cable loop. The recommended starting point is the first hole (closest to elbow centre). The closer to the joint the bracket is located the more force is required to flex the elbow.

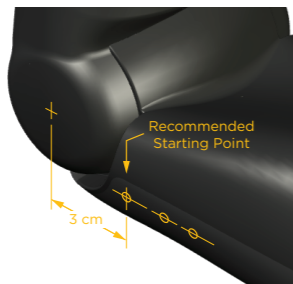

10.2 Setting Up the Cable Mounting

Drill Mounting Hole

A (17/64in or 6.75mm) drill bit and collar are provided to control the depth of the hole that is drilled. Carefully drill the mounting hole. Do not drill beyond the forearm shell surface or contact the internal mounting bracket.

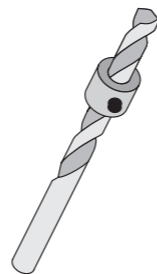

Attach Cable Loop

(or preferred cable anchor)

1. Fold the leather cable loop and fasten together with the rivet.
2. Align the cable loop to the hole. Attach with a 10-32 fastener and hand tighten.
3. Attach the preferred cable system to the prosthesis.

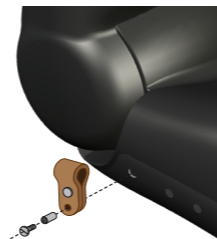

10.3 Terminal End Connections

There are many methods for attaching a lift cable to a terminal device. Two recommended options include:

Single Cable Control - to raise the forearm.

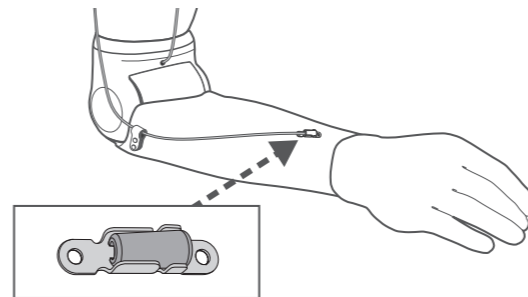

The lift cable is attached to a cosmetic arm terminal and then to the forearm. Allows for changing from hook to passive hand or powered terminal device.

Dual Cable Control - to raise the forearm and control the terminal device.

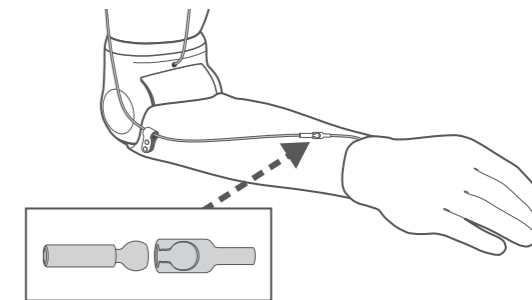

The lift cable is attached to a ball terminal and then connected to the terminal device. For use with most hands.

Terminal hardware not included. Refer to the manufacturer's instructions for assembly information.

SECTION 11 - SETTING UP THE COUNTERBALANCE (HYBRID)

11.1 Counterbalance Overview

The counterbalance assists in flexion and extension of the Espire Elbow. Different amounts of tension are necessary based on the elbow's overall length and the weight of the terminal device.

Note: The counterbalance mechanism is not removable or field-serviceable. Do not attempt to disassemble or modify the unit.

Adjustment Dial Location

The counterbalance dial can be installed on either the medial or lateral side of the elbow and should be specified at the time of ordering. Medial placement is the typical location.



Note: Adjustments are easier to make when the forearm is flexed.

Caution: Be aware that if the adjustment dial is at maximum tension and the arm is raised to a horizontal level, the elbow could suddenly flex.

Caution: To prevent injury, users should ensure the elbow is in the maximum flexed position when donning or doffing.

11.2 Counterbalance Adjustment

Direction	Adjustment	Result
	Turn the dial posteriorly to increase the counterbalance weight. Note: Elbow cannot be over-adjusted. In this direction, it will simply reach maximum flexion.	Supports more load on the elbow
	Turn the dial anteriorly to decrease the counterbalance weight Note: Elbow will spring back into flexion according to how much spring lift assist is put into the system if it exceeds the minimum adjustment.	Supports less load on the elbow

Note: The direction of adjustment would be opposite if on the lateral aspect of the elbow. There is a sticker that indicates + or - on the dial to indicate more or less assist to lift.

SECTION 12 - MAINTENANCE AND TROUBLESHOOTING

12.1 Troubleshooting



Caution: The Espire Elbow should never be serviced while connected to the end-user. Ensure that the device is disconnected and powered off before any service or maintenance is performed. This device should never be serviced while in use. Never let children handle this device unsupervised. Take caution when using this device around pets that may cause damage to the device.

The Espire Elbow features a single, multi-coloured LED Indicator located on the centre of the forearm near the elbow joint. This LED is used to display things such as battery life, calibration start and stop times and system errors. The chart outlines what each of the different LED patterns means. When the device is turned on the LED will blink briefly. Once the device is on, battery life can be checked by pressing the power button for one second.



Caution: Powering the elbow on before donning or leaving the elbow on before doffing can cause unintended movement of the prosthesis.

Espire Elbow All LED Indications

Colour	Indicator	Status
4 Green Blinks		Battery 100% Charged
3 Green Blinks		Battery Less Than 75%
2 Green Blinks		Battery Less Than 50%
1 Green Blink		Battery Less Than 25%
Yellow Solid		Critically Low - Charge Battery
Red Blinking		Minor System Error (Battery Overpowered, Object Too Heavy)
Red Solid		Critical Error (Contact Steeper Group)
Blue Solid		Bluetooth Connection

If the Espire Elbow system becomes unresponsive or control becomes erratic, try the following:

- Turn the system off, wait several seconds and power back on.
- Perspiration can diminish the performance of myoelectrodes. Wipe down the inside of the prosthetic socket with a clean cloth, including the electrodes. The inside of the socket may also be cleaned with mild soap and a damp cloth or isopropyl alcohol.
- Ensure that all visible wire connections are secure, and no wires have become entangled or frayed.
- Make sure the battery has sufficient charge. If the battery is too low, swap it with an extra, fully charged battery. Ensure that the battery is fully inserted into the Espire Elbow.
- If using TruSignal AC electrodes, recalibrate the system.

12.2 Maintenance

The Espire Elbow cannot be maintained in the field, and must be returned for repair/service. For support on maintenance please contact your local distributor or Product Manager.

SECTION 13 - INTENDED USE AND SAFETY

13.1 Intended Use

Intended Use Statement

The Espire Elbow is to be used exclusively for external prosthetic fittings of the upper limbs. The Espire Elbow processes the end-user's input signals to activate and control powered elbow movement.

Intended Users

The Espire Elbow is intended for use only by the individual being fit with the device. The manufacturer does not approve use by any other person/s. The Espire Elbow system is only to be purchased, configured and fit by a qualified prosthetist.

13.2 Indications and Contraindications

Indications for use of the Espire Pro or Hybrid elbow system include the following:

- Adequate limb length to allow for appropriate socket fit at a level above the elbow. This would include elbow disarticulation, transhumeral, shoulder disarticulation and forequarter

- Adequate muscle activity for myoelectric control (if utilised)
- Adequate cognitive ability to master technology and input requirements of device
- The patient is able and willing to participate in training for use of the myoelectric control of the prosthesis (if utilised)
- Access to a qualified prosthetist for fitting and servicing of the elbow system
- Able and willing to charge power source on a daily basis





Contraindications for use of the Espire Pro or Hybrid elbow system include the following:

- Any condition that prevents socket fitting, such as a complicated wound or intractable pain which precludes socket wear
- Inability to tolerate the weight of the prosthesis
- Inability to produce muscle or body movement necessary for operation of the terminal device(s)
- Specific environmental factors—such as excessive moisture or dust, or inability to charge the prosthesis
- Extremely rural conditions where maintenance ability is limited

13.2 Safety

Please ensure the user is fully aware of all safety instructions before leaving the clinic.

Legend of Symbols

-  Note: Possible technical damage.
-  Info: Basic information regarding this product.
-  Caution: Possible risk of accident or injury.
-  Warning: Possible risk of severe accident or injury.
-  Caution: Failure to follow the safety instructions that follow can lead to damage or malfunction of the product. Follow the safety instructions and stated precautions in this document.

Safety Instructions

-  Info: Use on aeroplanes
Airlines may not permit the use of this device on their aircraft. Check with your airline before traveling to ensure this device is allowed for use on the plane.

-  Info: Disposal
These products may not be disposed of with household waste in some jurisdictions. Disposal that is not in accordance with the regulations of your country may have a detrimental impact on health and the environment. Please observe the information provided by the responsible authorities in your country regarding return and collection processes.

-  Caution: Battery Damage
Damage can occur to the battery when dropping, knocking, crushing, vibrating or puncturing. Avoid damaging lithium batteries and devices. Always inspect for signs of damage, such as hissing, leaking, cracking/bulging and smoking before use. Immediately remove a device or battery from service, and place away from flammable materials if any of these signs are present. In the event of battery damage, immediately and carefully remove battery and please contact your certified Prosthetist regarding safe disposal and replacement. In the event of contact with the skin rinse immediately and contact medical care immediately.

-  Caution: Manipulation of system components
Independent changes and/or modifications to system components may lead to faulty control or malfunction of the Espire Elbow, resulting in a risk of injury. No modifications on your Espire Elbow except those described in this information document are authorised. The Espire Elbow and damaged components may only be opened or repaired by certified Steeper Group technicians.



Caution: Penetration of dirt and humidity

The penetration of dirt and humidity may lead to faulty control or malfunction of the Espire Elbow and result in a risk of injury. Ensure that neither solid particles nor liquids penetrate the Espire Elbow.



Caution: Mechanical overloading

External mechanical influences or loads, such as impacts and vibration, can lead to faulty control or malfunction of the Espire Elbow and result in a risk of injury. The Espire Elbow should not be subjected to mechanical vibrations or impacts.



Caution: Thermal overloading

Extreme temperature conditions can lead to faulty control or malfunction of the Espire Elbow and result in a risk of injury. Avoid areas outside the specified operating temperature range. The operating temperature range must be between 5°C and 40°C (41.0°F and 104°F).



Caution: Magnetic interference

The Espire Elbow and connected components can malfunction when near high-tension power lines, transmitters, transformers, or other sources of strong electromagnetic radiation (such as security systems for goods in department stores). This can result in a risk of injury. The electrodes should be set to as low a sensitivity as possible. The electrode settings should be checked by the prosthetist if patient reports repeated occurrences of malfunctions.



Caution: Improper use

Any type of excessive strain, overload or improper use may lead to faulty control or malfunction of the Espire Elbow, resulting in a risk of injury. The Espire Elbow was developed for everyday use and must not be used for unusual activities. These unusual activities include, for example, sports with excessive strain and/or shocks to the wrist joint (push-ups, downhill mountain biking, etc.) or extreme sports (free climbing, para-gliding, etc.). Do not use for swimming or in wet environments. Careful handling of the prosthesis and its components not only increases their service life but, will ensure the safety of the user. Should the prosthesis be subjected to unusual stresses (such as a fall), immediately contact a certified prosthetist and have the prosthesis inspected for any damage.



Caution: Lifting objects

Do not exceed the active lift limit of 10lbs/4.5kg.



Caution: Consequences of product deterioration

Wear and tear on system components can lead to malfunction of the Espire Elbow, resulting in a risk of injury. Follow the specified service intervals. The service life of this device is 2 years for device, parts, and accessories. Battery packs should be rotated in use of device, allowing a battery pack to not be used for more than 3 months can degrade the service life.



Caution: Water and Humidity

The electrical and mechanical systems of your Espire Elbow are not water-resistant. Water must be prevented from entering the Espire Elbow. Be careful not to let water run over the top of the prosthetic glove and enter the Espire Elbow as well as the terminal device. If water enters the inside of the prosthesis for any reason, immediately switch off all components and stop using or charging them. A certified prosthetist must be contacted immediately to assess the device and avoid further damage.



Caution: Risk of accident while operating a vehicle

An upper extremity amputee's ability to drive a vehicle is determined on a case-by-case basis. Factors include the type of fitting (amputation level, unilateral or bilateral, residual limb conditions, design of the prosthesis) and the amputee's abilities. All persons are required to observe their country's national and state driving laws when operating vehicles. For insurance purposes, drivers should have their driving ability examined and approved by an authorised test centre. For maximum safety and convenience, Steeper Group recommends that, at the very least, a specialist evaluate the need for any adaptations to the car. It is indispensable to ensure that the driver can operate the vehicle without any risk with the Espire Elbow turned off. Driving with the Espire Elbow turned ON may present a risk if the Espire Elbow inadvertently moves due to unintentional muscle contraction or other causes. A doctor or prosthetist should be consulted before operating a motor vehicle with this device; otherwise the Espire Elbow is not approved for use while driving.



Caution: Too close to HF communication devices (e.g. mobile phones, Bluetooth devices, WIFI devices)

If too close to HF communication devices, interference with internal data communications can result in malfunctions of the product. This can lead to a risk of injury. Therefore, keeping the following minimum distances from these HF communication devices is recommended.

Portable RF communications equipment (including peripherals such as antenna cables and external antennas) should be used no closer than 30 cm (12 inches) to any part of the Espire Elbow, including cables specified by the manufacturer. Otherwise, degradation of the performance of this equipment could result.



Caution: EM Disturbances

Do not use the Espire Elbow near active HF SURGICAL EQUIPMENT and the RF shielded room of an EM SYSTEM for magnetic resonance imaging, where the intensity of EM DISTURBANCES is high. High levels of Electro Magnetic disturbances may cause system to stop functioning properly, either not responding to input signal(s) or no movement of the joints.

**Caution: Overheating of drive unit**

Continuous use of the Espire Elbow over a longer period (e.g. frequent lifting and lowering) can lead to overheating of the drive unit. Touching overheated components can result in painful situations. Caution should be exercised during use by patients having skin with decreased heat sensitivity. In case of overheating the performance of the Espire Elbow is impaired and the full lifting force can no longer be utilised. The activities must be discontinued until the drive unit has cooled. After cooling the full functionality is restored.

**Caution: Risk of pinching where the elbow joint bends**

Ensure that fingers and other body parts are not in this area when bending the elbow joint.

**Caution: Operating the product near active implanted systems**

When operating the product, there is a risk of temporary influences of active implantable systems (e.g. pacemakers, defibrillators etc.) because of electromagnetic interference of the product.

When operating the product in the immediate vicinity of active implantable systems, ensure that the minimum distances stipulated by the manufacturer of the implant are observed.

Make sure to observe any operating conditions and safety instructions stipulated by the manufacturer of the implant.

**Caution: Unsupervised Use**

It is not recommended for children to operate this device without the supervision of an adult. Use extreme caution around small children and household pets.

**Warning: Using with Other Equipment**

Use of this equipment adjacent to or stacked with other equipment should be avoided because it could result in improper operation. If such use is necessary, any equipment needs to be agreed appropriate with their Prosthetist and/or Steeper.

**Warning: Use Only Specified Equipment**

Use of accessories, transducers and cables other than those specified or provided by the manufacturer of this equipment could result in increased electromagnetic emissions or decreased electromagnetic immunity of this equipment and result in improper operation.

**Warning: Operation of Equipment in Hospitals**

The Espire Elbow was designed for use in residential environments (home, restaurants, etc.) not hospitals or industrial areas. If device is used in environments such as hospitals or industrial areas, the user might have to relocate to operate the device appropriately so that it is away from other HF radio devices.

Complies with Standards

No.	Description	Version
ISO 22523	External limb prostheses and external orthoses – Requirements and test methods	2006
AAMI ANSI 60601-1	Medical Electrical Equipment – Part 1: General requirements for basic safety and essential performance	2007/ (R) 2012 and A1:2012
IEC 60601-1-2	Medical Electrical Equipment – Part 1-2: General requirements for basic safety and essential performance – Collateral standard: Electromagnetic compatibility – Requirements and tests	Edition 4.0 2014
IEC 60601-1-6	Medical Electrical Equipment – Part 1-6: General requirements for basic safety and essential performance – Collateral standard: Usability	2013 Ed 3.1
IEC 62366-1	Medical Devices – Part 1: Application of Usability Engineering to Medical Devices	2015 Ed 1
IEC 60601-1-11	Medical Electrical Equipment – Part 1-11: General requirements for basic safety and essential performance – Collateral standard: requirements for medical electrical equipment and medical electrical systems used in the home healthcare environment	2015 Ed 2
IEC 62304	Medical Device Software – Software Life Cycle Processes	2006 Ed 1 +A1
ISO 10993-1	Biological evaluation of medical devices – Part 1: Evaluation and testing within a risk management process	2009

No.	Description	Version
ISO 10993-5	Biological evaluation of medical devices – Part 5: Tests for in vitro cytotoxicity	2009
ISO 10993-10	Biological evaluation of medical devices – Part 10: Tests for irritation and skin sensitisation	2010
FCC Part 15	Radio Frequency	
IEC 62133	Secondary cells and batteries containing alkaline or other non-acid electrolytes – Safety requirements for portable sealed secondary lithium cells, and for batteries made from them, for use in portable applications – Part 2: Lithium systems	2017

EMC Compliance – Specific Mitigations

The Espire Elbow was tested to the listed standards at the appropriate levels for Home Health Care Equipment below to ensure safety of the product regarding immunity and emissions. All devices maintained their performance during and after the tests were completed.

This device complies with part 15 of the FCC rules. Operation is subject to the following two conditions. (1) This device may not cause harmful interference. (2) This device must accept any interference received, including interference that may cause undesired operation.

This device complies with Industry Canada license-exempt RSS standard(s). Operation is subject to the following two conditions: (1) this device may not cause interference, and (2) this device must accept any interference, including interference that may cause undesired operation of the device.



Le présent appareil est conforme aux CNR d'Industrie







Canada applicables aux appareils radio exempts de licence. L'exploitation est autorisée aux deux conditions suivantes: (1) l'appareil ne doit pas produire de brouillage, et (2) l'utilisateur de l'appareil doit accepter tout brouillage radioélectrique subi, même si le brouillage est susceptible d'en compromettre le fonctionnement.





Phenomenon & Standard	Test Level	Remarks
Radiated Emissions CISPR11 ed5.0 (with A1:2010), CISPR 11 ed6.1 (2015 +A1:2016)	Group 1, Class B	The Espire Elbow uses RF energy only for its internal function. Therefore, its RF emissions are very low and are not likely to cause any interference in nearby electronic equipment.
Electro-Static Discharge Immunity Test IEC 61000-4-2 ed2.0 (2008-12)	Contact ± 8 kV Air ± 2 kV, ± 4 kV, ± 8 kV, ± 15 kV	The Espire Elbow is attached to the patient's socket which is designed by a certified prosthetist.

Radiated, Radio-Frequency, Electromagnetic Immunity IEC 61000-4-3 ed3.0 (with A1:2007+A2:2010)	10 V/m 80 MHz - 2,7 GHz	Portable and mobile RF communications equipment should be used no closer to any part of the Espire Elbow, including cables, than the recommended in the Technical manual. Device does not need to be operated in a shielded environment.
Power Frequency Magnetic Field Immunity Test IEC 61000-4-8 ed2.0 (2009-09)	30 A/m, 50 Hz or 60 Hz	The Espire Elbow should not be operated closer than 15 cm of sources of power frequency magnetic field.

Definitions of symbols used in this device and its packaging

Symbol	Definition	Source
	Consult instructions for use.	BS EN ISO 15223-1:2012 Reference no. 5.4.3
	Keep dry.	BS EN ISO 15223-1:2012 Reference no. 5.3.4

Symbol	Definition	Source
	This product contains electrical and electronic components that may contain materials which, if disposed with general waste, could be damaging to the environment. Residents of the European Union must follow specific disposal or recycling instructions for this product. Residents outside the European Union must dispose or recycle this product in accordance with local laws or regulations that apply.	IS EN 50419:2006 Reference no. Fig.1
	Caution: Federal (USA) law restricts this device to sale by or on the order of a physician.	USA Code of Federal Regulations 21 CFR Part 801 § 801.109(b)(1)
	Refer to instruction manual/booklet.	IEC TR 60878 Ed. 3.0 b:2015
	The requirements for accreditation and market surveillance relating to the marketing of products; Medical Device Directive.	765/2008/EC 768/2008/EC MDD 93/42/EEC Articles 4,11,12,17, Annex II)
	Type BF applied part.	IEC 60601-1 IEC 60878 ISO 9687:2015 Reference no. 5334
	Temperature limit.	ISO 15223-1 Reference no. 5.3.7

Symbol	Definition	Source
	Storage humidity range.	ISO 15223-1 Reference no. 5.3.8
IP22	Protection against solid foreign objects of 12.5 mm diameter and greater, and protection against vertically falling water drops when tilted up to 15 degrees.	IEC 60601-1, Table D.3, Symbol 2
	Bluetooth® wireless or enabled technology.	Trademarks of Bluetooth Special Interest Group (SIG)
	Complies with Australian Radio communications requirements.	AS/NZS 4417.1:2012
	Medical device manufacturer.	ISO 15223-1, Clause 5.1.1
	21 CFR Part 15 Meets FCC requirements per 21 CFR Part 15.	Federal Communications Commission
	Battery is recyclable - follow local recycling & reclaiming procedures.	ISO 7000 Reference no. 1135
	China RoHS Mark I logo. Product does not contain toxic and hazardous substances or elements above the clip level in any material or application including those exempt from the requirements of the EU RoHS Directive.	SJ/T11364-2006

Steeper Group
Unit 3 Stourton Link, Intermezzo Drive
Leeds, LS10 1DF
Tel: +44 (0) 870 240 4133
Email: customerservices@steepergroup.com

SteeperUSA
8666 Huebner Road, Suite 112
San Antonio, TX 78240
Tel: (+1) 210 481 4126
Email: inquiries@steeperusa.com

STPPR127 Issue 1 November 2020

 Steeper Group, Unit 3 Stourton Link,
Intermezzo Drive, Leeds, UK, LS10 1DF

 MADE IN THE UK
©2020 Steeper Group
All rights reserved.

 **steeper**
Creating life's turning points, together